

Spherical roller bearings, cylindrical and tapered bore

Principal dimensions			Basic load ratings		Speed ratings		Designation
d	D	B	dynamic C	static C0	Reference speed	Limiting speed	
mm			kN		r/min		
360	480	90	1456	2750	1200	1300	* SKF Explorer bearing 23972 CCK/W33 *

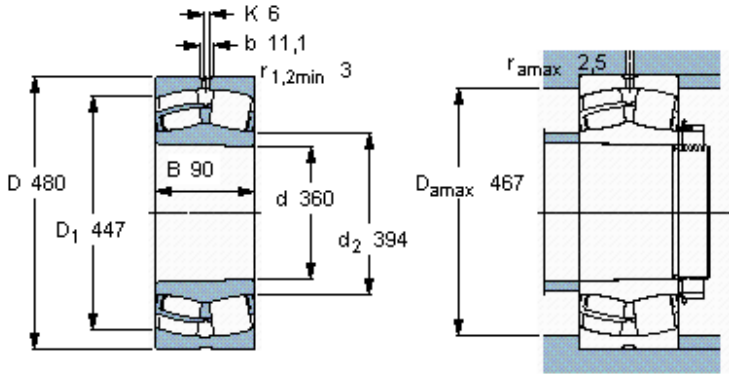

Tapered bore, taper
1: 12

Calculation factors

- e 0,15
- Y_1 4,5
- Y_2 6,7
- Y_0 4,5